



DC-UPS WITH INTEGRATED BATTERY

- Compact and Easy to Install
- Longest Buffer Time in Class
- Easy Battery Access
- Stable Output Voltage in Buffer Mode
- Superior Battery Management for Longest Battery Life
- Temperature Compensated Battery Charging
- Comprehensive Diagnostics and Monitoring Functions
- Replace Battery Signal Included
- Electronically Overload and Short Circuit Protected
- 50% Power Reserves
- Selectable Buffer Time Limiter

PRODUCT DESCRIPTION

This uninterruptible power supply (UPS) controller UBC10.241 with integrated battery is a compact addition to standard 24V power supplies to bridge power failures or voltage fluctuations. Expensive downtimes, long restart cycles and loss of data can be avoided.

The DC-UPS includes a professional battery management system which charges and monitors the battery to achieve the longest battery service life as well as many diagnostic functions that ensure a reliable operation of the entire system.

A unique feature of the UBC10.241 is that only one 12V battery is required to buffer the 24V output. This makes matching batteries unnecessary and allows a precise battery charging and testing.

The UBC10.241 has one integrated 12V 5Ah high current VRLA battery, which is easy to change.

In addition to the UBC10.241, a separate UPS controller (UB10.241) which requires an external 12V battery is available when a longer buffer time is required.

SHORT-FORM DATA

Input voltage range	nom. 24Vdc 22.5-30Vdc	
Output current	min. 15A min. 10A	Normal mode Buffer mode
Output voltage	typ. 0.23V lower as input voltage 22.25V	Normal mode Buffer mode, 10A
Integrated battery	12V 5Ah	VRLA lead acid
Temperature range	0 to 40°C	Operational
Dimensions	123x124x119mm	WxHxD
Buffer time	typ. 16'15" typ. 6'15"	At 5A load At 10A load

Typical setup of a DC-UPS system with the UBC10.241:

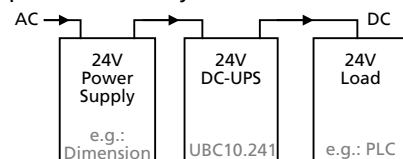

ORDER NUMBERS

DC-UPS	UBC10.241 UBC10.241-N1	Standard Unit Battery not assembled
Accessory	UZB12.051	Battery module 12V 5Ah

MAIN APPROVALS

For details and the complete approval list, see chapter 19.



UL 508



Marine



UL 60950-1



Marine



ATEX

INDEX PAGE

1. Intended Use	3
2. Installation Instruction	3
3. Input	5
4. Output in Normal Mode	6
5. Output in Buffer Mode	7
6. Battery	8
7. Buffer Time	9
8. Efficiency and Power Losses	10
9. Functional Diagram	10
10. Check Wiring and Battery Quality Tests	11
11. Relay Contacts and Inhibit Input	12
12. Front Side and User Elements	14
13. Terminals and Wiring	15
14. Reliability	15
15. EMC	16

INDEX PAGE

16. Environment	17
17. Protection Features	17
18. Safety	18
19. Approved, Fulfilled or Tested Standards	19
20. Regulatory Product Compliance	20
21. Physical Dimensions and Weight	21
22. Installation Notes	22
23. Replacement of the battery	23
24. Accessories	24
24.1. Battery	24
25. Application Notes	25
25.1. Battery Replacement Intervals	25
25.2. Parallel and Serial Use	26
25.3. Using the Inhibit Input	27
25.4. Troubleshooting	27

TERMINOLOGY AND ABBREVIATIONS

DC-UPS	Uninterruptible power supply with DC-Input.
Normal mode	Describes a condition where the battery is charged, the input voltage is in range and the output is loaded within the allowed limits.
Buffer mode	Describes a condition where the input voltage is below the transfer threshold level, the unit is running on battery (buffering) and the output is loaded within the allowed limits.
Charging mode	Describes a condition where the battery is being charged, the input voltage is in range and the output is loaded within the allowed limits.
Inhibit mode	Describes a condition where buffering is disabled on purpose by using the inhibit input of the DC-UPS. (e.g. for service actions, or to save battery capacity)
Buffer time	Same as the term "hold-up time".
T.b.d.	To be defined, value or description will follow later.

DISCLAIMER

The information presented in this document is believed to be accurate and reliable and may change without notice. Some parts of this unit are patent by PULS (US patent No 091662,063, Des. 424,529, ...).

No part of this document may be reproduced or utilized in any form without permission in writing from the publisher.

1. INTENDED USE

This device is designed for installation in an enclosure and is intended for commercial use, such as in industrial control, process control, monitoring and measurement equipment or the like. Do not use this device in equipment where malfunction may cause severe personal injury or threaten human life.

2. INSTALLATION INSTRUCTION

⚠ WARNING Risk of electrical shock, fire, personal injury or death.

- Turn power off before working on the device and protect against inadvertent re-powering.
- Do not open, modify or repair the device.
- Use caution to prevent any foreign objects from entering into the housing.
- Do not use in wet locations or in areas where moisture or condensation can be expected.
- Do not touch during power-on, and immediately after power-off. Hot surface may cause burns.

Obey the following installation instructions:

This device may only be installed and put into operation by qualified personnel.

This device does not contain serviceable parts. The tripping of an internal fuse is caused by an internal defect.

If damage or malfunction should occur during installation or operation, immediately turn power off and send unit to the factory for inspection.

Turn power off and disconnect the battery fuse before working on the device.

Install the device in a cool area inside an enclosure providing protection against electrical, mechanical and fire hazards. Ensure sufficient ventilation by following the requirements of the EN 50272-2.

Install the device onto a DIN rail according to EN 60715 with the input terminals on the top of the unit. The input can be powered from a regulated power supply or a similar DC source. The voltage between the input and ground must not exceed 60Vdc continuously. The ripple voltage in the low frequency range between 50Hz and 10kHz must be negligible when used in marine applications.

The input must be powered from a PELV or SELV source or an "Isolated Secondary Circuit" in order to maintain a SELV or PELV output.

Use an appropriately sized 24V power supply, which can deliver the additional internal current consumption, required to charge the battery.

Use only VRLA lead acid batteries with a capacity between 4.5Ah and 6Ah.

Check for correct input and battery polarity. The device will not operate when the voltage is reversed. Make sure that the wiring is correct by following all local and national codes. Use appropriate copper cables that are designed for a minimum operating temperature of 60°C. Ensure that all strands of a stranded wire enter the terminal connection.

The device is designed for pollution degree 2 areas in controlled environments. No condensation or frost is allowed.

The device is designed as "Class of Protection III" equipment according to IEC 61140.

The enclosure of the device provides a degree of protection of IP20.

A disconnecting means shall be provided for the output of the device.

The device is designed for convection cooling and does not require an external fan. Do not obstruct airflow and do not cover ventilation grid!

Keep the following minimum installation clearances: 40mm on top, 20mm on the bottom, 5mm left and right side. Increase the 5mm to 15mm in case the adjacent device is a heat source. When the device is permanently loaded with less than 50%, the 5mm can be reduced to zero.

The device is designed for altitudes up to 6000m (19685ft).

The maximum surrounding air temperature is +40°C (+104°F). The operational temperature is the same as the ambient or surrounding air temperature and is defined 2cm below the device.

Aug. 2021 / Rev. 1.5 DS-UBC10.241-EN

All parameters are specified at an input voltage of 24V, 10A output load, 25°C ambient and after a 5 minutes run-in time unless otherwise noted. It is assumed that the input power source deliver a sufficient output current.can

The device is designed to operate in areas between 5% and 95% relative humidity.

Do not install the battery fuse until the installation work is complete.

To avoid an unintended buffering event, disconnect the battery fuse or use the inhibit input.

Replacement fuses must be of the same type (ATOF® 287 030 from Littelfuse) or an UL listed fuse with the same nominal value and characteristics.

Do not store the device at temperatures higher than 25°C or performance and lifetime may change. Before initial use, check the last charging which is marked on the battery. If it is older than 9 months, replace the battery.

Do not store batteries longer than 9 months without charging or performance and lifetime may change. Every 9 months or whenever the open circuit voltage (OCV) falls below 12.6V, the battery should be charged. Apply a charging voltage of 13.8V (at 25°C) for 72 hours. Batteries with an OCV below 12V must not be charged anymore and must be disposed.

Frequently charging below +5°C reduces the lifetime of the battery.

Do not use batteries other than the original batteries supplied by the manufacturer to avoid conflicts with agency approvals.

CAUTION: The unit contains wet cell batteries. Ventilation of the installation room in accordance with the rules of Canadian Electrical Code, part 1 is required if used in Canada.

Instructions for replacement and disposal of batteries:

Batteries need to be replaced periodically. The time interval depends on the ambient temperature in which the battery is used and, on the number, and depth of discharge cycles. In a typical application it is recommended to replace the batteries at least every 2 years. Disconnect battery fuse before replacing the batteries.

Always dispose batteries through a recycling organization. Optionally, batteries can be returned to the supplier or the battery manufacturer. Batteries must be completely discharged before recycling.

Installation Instructions for Hazardous Location Areas

The device is suitable for use in Class I Division 2 Groups A, B, C, D locations and for use in Group II Category 3 (Zone 2) environments.

Hazardous Location Classification: ATEX: EPS 15 ATEX 1 025 X, II 3G EX ec nC IIC T3 Gc

WARNING EXPLOSION HAZARDS!

Substitution of components may impair suitability for this environment.

Do not disconnect the device, change unit settings or remove or insert the fuse unless power has been switched off or the area is known to be non-hazardous.

A suitable enclosure must be provided for the end product which has a minimum protection of IP23 and fulfils the requirements of the EN 60079-0. Sufficient ventilation must be ensured in the final installation.

Do not use batteries other than the original batteries supplied by the manufacturer or batteries, which are approved according to EN/ IEC 60079-7.

3. INPUT

Input voltage	nom.	DC 24V	
Input voltage ranges	nom.	22.5-30Vdc 30-35Vdc 35Vdc 0-22.5Vdc	Continuous operation, see Fig. 3-1 Temporarily allowed, no damage to the DC-UPS*) Absolute maximum input voltage with no damage to the DC-UPS The DC-UPS switches into buffer mode and delivers output voltage from the battery if the input was above the turn-on level before and all other buffer conditions are fulfilled.
Allowed input voltage ripple	max.	1.5Vpp 1Vpp	Bandwidth <400Hz Bandwidth 400Hz to 1kHz
Allowed voltage between input and earth (ground)	max.	60Vdc or 42.4Vac	
Turn-on voltage	typ.	22.8Vdc	The output does not switch on if the input voltage does not exceed this level.
	max.	23Vdc	
Input current**)	typ.	120mA	Internal current consumption
	typ.	1.1A	Current consumption for battery charging in constant current mode at 24V input See Fig. 6-2 ***)
External capacitors on the input		No limitation	

*) The DC-UPS shows "Check Wiring" with the red LED and buffering is not possible

***) The total input current is the sum of the output current, the current which is required to charge the battery during the charging process and the current which is needed to supply the DC-UPS itself. See also Fig. 3-2. This calculation does not apply in overload situations where the DC-UPS limits the output current, therefore see Fig. 3-3.

***) Please note: This is the input current and not the current which flows into the battery during charging. The battery current can be found in chapter 6.

Fig. 3-1 Input voltage range

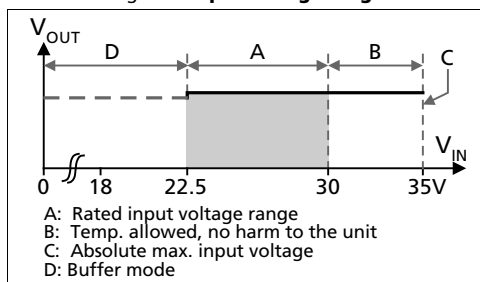
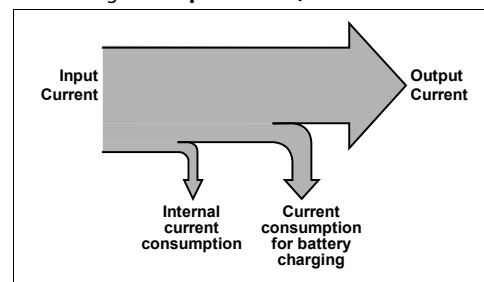

Fig. 3-2 Input current, definitions



Electronic output current limitation

The DC-UPS is equipped with an electronic output current limitation. This current limitation works in a switching mode which reduces the power losses and heat generation to a minimum. As a result, the output voltage drops since there is not enough current to support the load. A positive effect of the current limitation in switching mode is that the input current goes down despite an increase in the output current resulting in less stress for the supplying source.

Fig. 3-3 Input current and output voltage vs. output current, typ. (battery fully charged)

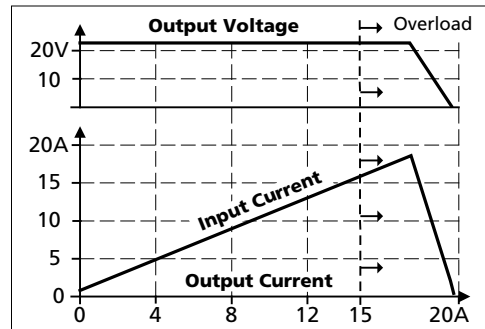

4. OUTPUT IN NORMAL MODE

Output voltage in normal mode	nom.	DC 24V	The output voltage follows the input voltage reduced by the input to output voltage drop.
Voltage drop between input and output	max.	0.3V	At 10A output current, see Fig. 4-1 for typical values
	max.	0.45V	At 15A output current, see Fig. 4-1 for typical values
Ripple and noise voltage	max.	20mVpp	20Hz to 20MHz, 50Ohm ^{*)}
Output current	nom.	15A	Continuously allowed
Output power	nom.	360W	Continuously allowed
Short-circuit current	min.	17.9A	Load impedance 100mOhm, see Fig. 4-2 for typical values
	max.	21A	Load impedance 100mOhm, see Fig. 4-2 for typical values
Capacitive and inductive loads	No limitation		

*) This figure shows the ripple and noise voltage which is generated by the DC-UPS. The ripple and noise voltage might be higher if the supplying source has a higher ripple and noise voltage.

Fig. 4-1 Input to output voltage drop, typ.

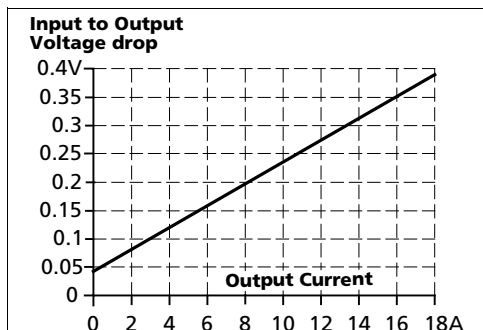
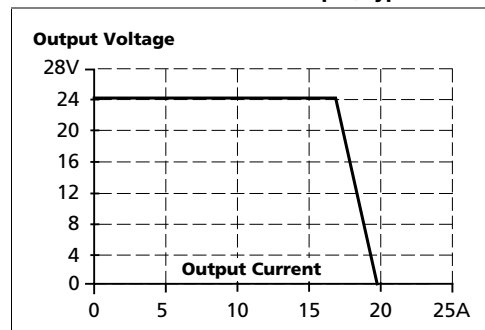

Fig. 4-2 Output voltage vs. output current in normal mode at 24V input, typ.



5. OUTPUT IN BUFFER MODE

If the input voltage falls below a certain value (transfer threshold level), the DC-UPS starts buffering without any interruption or voltage dips. Buffering is possible even if the battery is not fully charged.

Output voltage in buffer mode	nom.	DC 24V	Output voltage is stabilized and independent from battery voltage
		22.45V	±1%, at no load,
		22.25V	±1%, at 10A output current
Transfer threshold for buffering	typ.	80mV higher than the output voltage in buffer mode	
Ripple and noise voltage	max.	20mVpp	20Hz to 20MHz, 50Ohm
Output current	nom.	10A	Continuously allowed
		15A	< 5s with full output voltage ^{*)}
Short-circuit current	min.	17.9A	Load impedance 100mOhm ^{**)}
	max.	21A	Load impedance 100mOhm ^{**)}

- *) If the output current is in the range between 10A and 15A for longer than 5s, a hardware-controlled reduction of the maximal output current to 10A occurs. If the 10A are not enough to maintain the 24V, buffering stops after another 5s. The buffering is possible again as soon as the input voltage recovers.
- ***) If the nominal output voltage cannot be maintained in buffer mode, the DC-UPS switches off after 5s to save battery capacity.

Fig. 5-1 Buffering transition, definitions

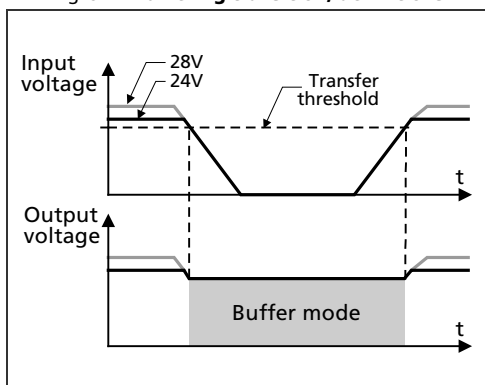

Fig. 5-2 Transfer behavior, typ.

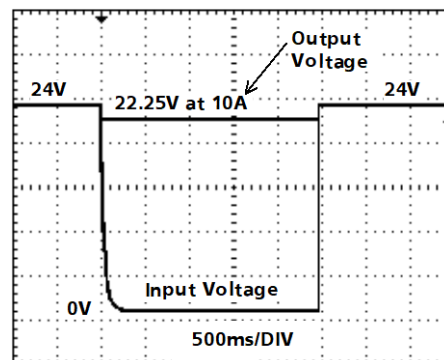

Fig. 5-3 Available output current in buffer mode

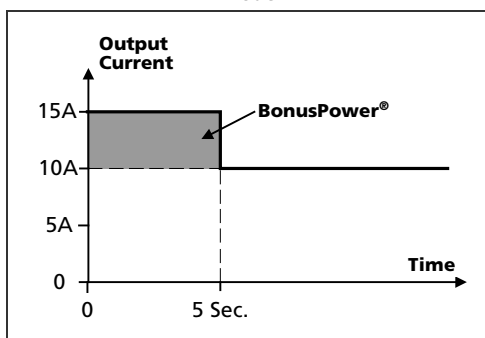
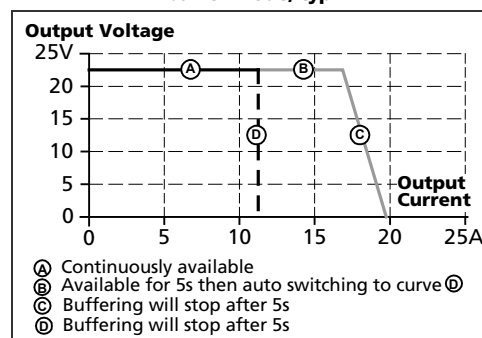

Fig. 5-4 Output voltage vs. output current in buffer mode, typ.



6. BATTERY

The required 12V VRLA battery is included with this unit. For more details on battery requirements see chapter 23.

Battery voltage	nom. DC 12V	Maintenance-free 12V VRLA lead acid battery.
Battery voltage range	9.0–15.0V	Continuously allowed, except deep discharge protection
	max. 35Vdc	Absolute maximum voltage with no damage to the unit.
	typ. 7.4V	Above this voltage level battery charging is possible
Allowed battery capacity	nom. 5Ah	High-current version
Battery charging method	CC-CV	Constant current, constant voltage mode
Battery charging current	nom. 1.5A	CC-mode, Independent from battery size
	max. 1.7A	Corresponding 24V input current see Fig. 6-2
End-of-charge-voltage (CV-mode)	typ. 13.1-14V	Automatic setting according to ambient temperature
Battery charging time	typ. 3h*)	
Battery discharging current**)	typ. 21A	Buffer mode, 10A output current, 11.5V on the battery terminal of the DC-UPS, see Fig. 6-1 for other parameters
	typ. 0.3A	Buffer mode, 0A output current
	max. 50µA	At no input, buffering had switched off, all LEDs are off
	typ. 270mA	At no input, buffering had switched off, yellow LED shows "buffer time expired" (max. 15 minutes)
Deep discharge protection***)	typ. 10.5V	At 0A output current
	typ. 9.0V	At 10A output current

*) The charging time depends on the duration and load current of the last buffer event. The numbers in the table represent a fully discharged battery. A typical figure for a buffer current of 10A is 2h 20Min. for a 5Ah high current battery. Above 40°C charging time can be longer.

***) The current between the battery and the DC-UPS is more than twice the output current. This is caused by boosting the 12V battery voltage to a 24V level.

***) To ensure longest battery lifetime, the DC-UPS has a battery deep discharge protection feature included. The DC-UPS stops buffering when the voltage on the battery terminals of the DC-UPS falls below a certain value.

Fig. 6-1 Battery discharging current vs. output current, typ.

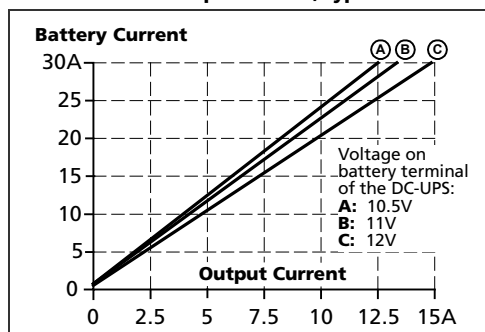
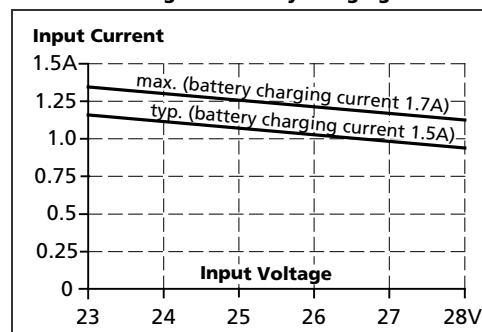

Fig. 6-2 Required input current vs. input voltage for battery charging



7. BUFFER TIME

The buffer time depends on the capacity and performance of the battery as well as the load current. The diagram below shows the typical buffer times of the standard battery.

Buffer time with 5Ah high-current battery	min.	13'24"	At 5A output current ^{*)}
	min.	4'54"	At 10A output current ^{*)}
	typ.	16'15"	At 5A output current, see Fig. 7-1 ^{**)}
	typ.	6'15"	At 10A output current, see Fig. 7-1 ^{**)}

^{*)} Minimum value includes 20% aging and requires a fully charged (min. 24h) battery.

^{**)} Typical value includes 10% aging and requires a fully charged (min. 24h) battery.

Fig. 7-1 **Buffer time vs. output current with a 5Ah high current battery**

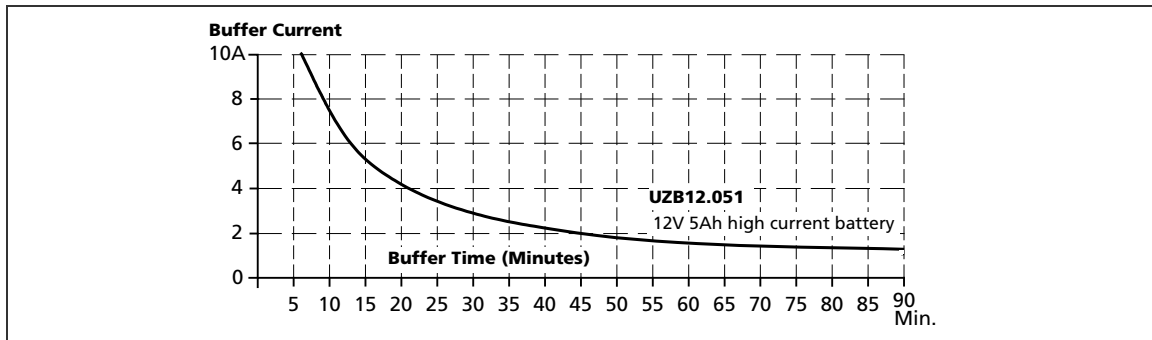

8. EFFICIENCY AND POWER LOSSES

Efficiency	typ.	97.8%	Normal mode, 10A output current, battery fully charged
Power losses	typ.	2.9W	Normal mode, 0A output current, battery fully charged
	typ.	5.5W	Normal mode, 10A output current, battery fully charged
	typ.	5.0W	During battery charging, 0A output current

Fig. 8-1 Efficiency at 24V, typ.

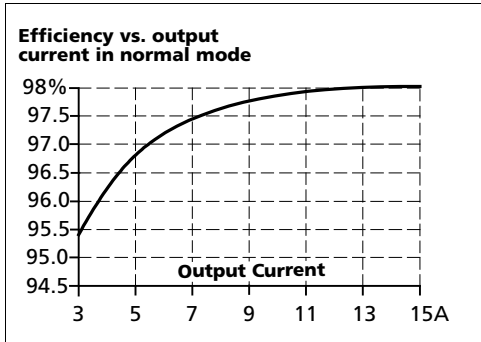
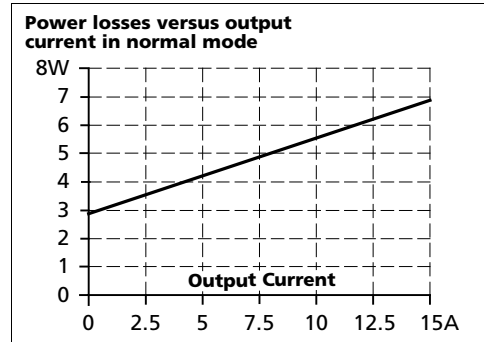
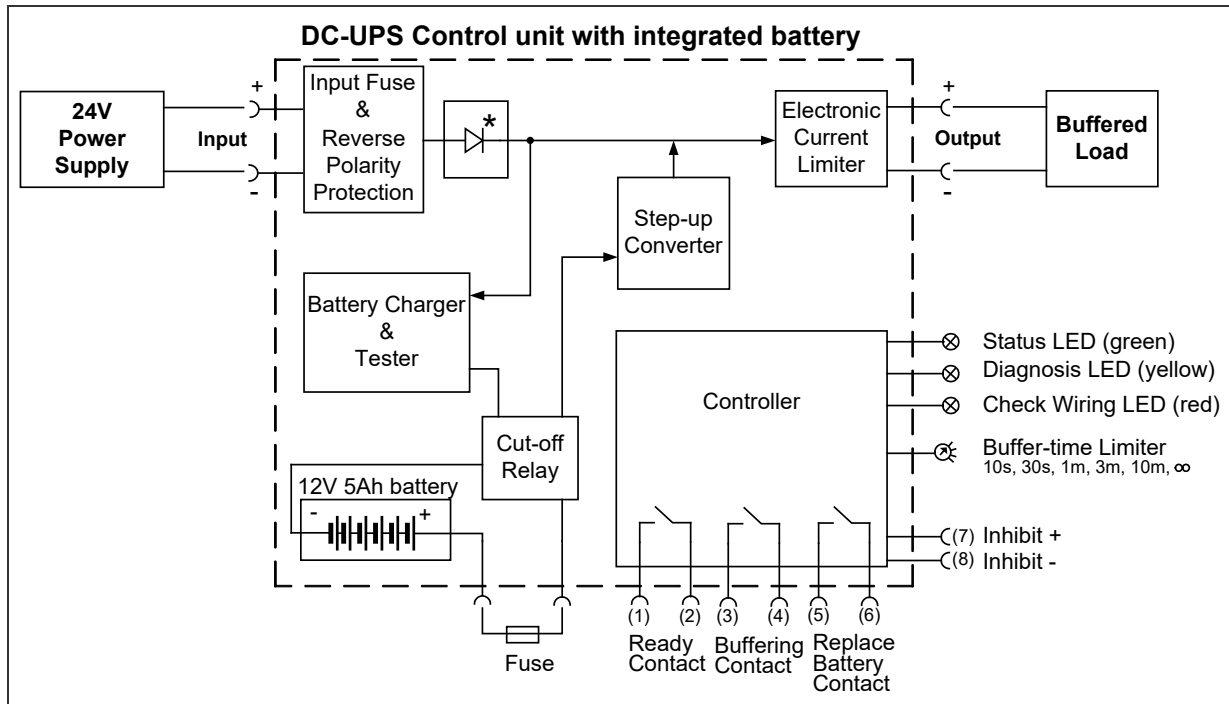

Fig. 8-2 Losses at 24V, typ.



9. FUNCTIONAL DIAGRAM

Fig. 9-1 Functional diagram



*) Return current protection; This feature utilizes a MOSFET instead of a diode in order to minimize the voltage drop and power losses.

10. CHECK WIRING AND BATTERY QUALITY TESTS

The DC-UPS is equipped with an automatic "Check Wiring" and "Battery Quality" test.

"Check Wiring" test:

Under normal circumstances, an incorrect or bad connection from the battery to the DC-UPS or a missing (or blown) battery fuse would not be recognized by the UPS when operating in normal mode. Only when back up is required would the unit not be able to buffer. Therefore, a "check wiring" test is included in the DC-UPS. This connection is tested every 10 seconds by loading the battery and analysing the response from the battery. If the resistance is too high, or the battery voltage is not in range, the unit displays "Check Wiring" with the red LED. At the same time the green "Ready" LED will turn off.

"State of Health" (SoH) test:

The battery has a limited service life and needs to be replaced in a fixed interval which is defined by the specified service life (acc. to the Eurobat guideline), based on the surrounding temperature and the number of charging/discharging cycles. If the battery is used longer than the specified service life, the battery capacity will degrade. Details can be found in chapter 25.1. SoH test can not determine a gradual loss in capacity. However, it can detect a battery failure within the specified service life of the battery. Therefore, a SoH-test is included in the DC-UPS.

The SoH test consists of different types of tests:

- During charging:
If the battery does not reach the ready status (see chapter 12) within 30h, it is considered to be defective. The reason could be a broken cell inside the battery.
- During operation:
Once the battery is fully charged, a voltage drop test and a load test is performed alternately every 8 hours. Three of the tests must consecutively produce negative results to indicate a battery problem.

A battery problem is indicated with the yellow LED (replace battery pattern) and the relay contact "Replace Battery". Please note that it can take up to 50 hours until a battery problem is reported. This should avoid nuisance error messages as any urgent battery problems will be reported by the "Check Wiring" test and create a warning signal. The battery tests require up to 50h uninterrupted operation. Any interruptions in the normal operation of the DCUPS may result in the "Replace Battery" test cycle to start over.

When "Replace battery" is indicated, it is recommended to replace battery as soon as possible.

11. RELAY CONTACTS AND INHIBIT INPUT

The DC-UPS is equipped with relay contacts and signal inputs for remote monitoring and controlling of the unit.

Relay contacts:

- Ready: Contact is closed when battery is charged more than 85%, no wiring failure are recognized, input voltage is enough and inhibit signal is not active.
- Buffering: Contact is closed when unit is buffering.
- Replace Battery: Contact is closed when the unit is powered from the input and the battery quality test (SOH test) reports a negative result.

Relay contact ratings	max.	60Vdc 0.3A, 30Vdc 1A, 30Vac 0.5A resistive load
	min.	1mA at 5Vdc min.
Isolation voltage	max.	500Vac, signal port to power port

Signal input:

- Inhibit: The inhibit input disables buffering. In normal mode, a static signal is required. In buffer mode, a pulse with a minimum length of 250ms is required to stop buffering. The inhibit is stored and can be reset by cycling the input voltage. See also section 25.1 for application notes.

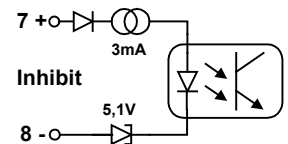

Signal voltage	max.	35Vdc
Signal current	max.	6mA, current limited
Inhibit threshold	min.	6Vdc, buffering is disabled above this threshold level
	max.	10Vdc
Isolation	nom.	500Vac, signal port to power port

Restriction apply when using the signal and relay contacts in a Haz-Loc environment:

The Buffering, Ready and Replace Battery contact is intended to be used for a separately investigated non incentive field wiring and/or field wiring apparatus. The DC-UPS may be located in a Class I, Division 2 (Group A, B, C or D) hazardous (classified) location. Associated apparatus must be installed in accordance with its manufacturer's control drawing and Article 504 of the National Electrical Code (ANSI/NFPA 70) for installation in the United States, or chapter 18 of the Canadian Electrical Code for Installations in Canada.

Selected associated apparatus must be third part listed as providing non incentive field circuits for the application, and have Voc not exceeding Vmax, Isc not exceeding Imax.

Non associated non incentive field wiring apparatuses shall not be connected in parallel unless this is permitted by the associated non incentive field wiring apparatuses approval.

Fig. 11-1 **Contact control drawing for use in Haz-Loc environments**

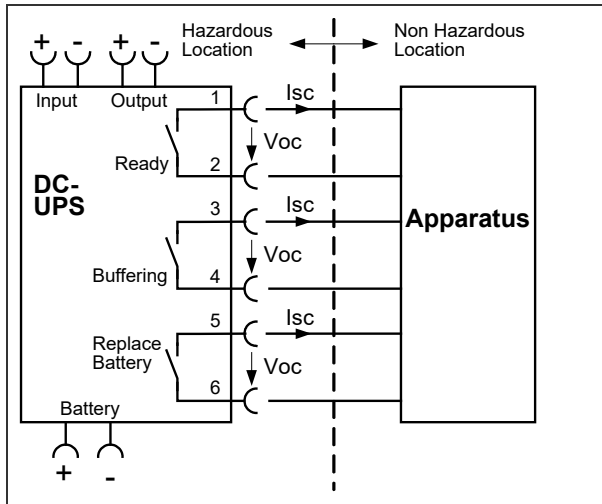

Selected barriers must have entity parameters such that
 $V_{oc} < V_{max}$, $I_{sc} < I_{max}$,
 $C_a > C_i + C_{cable}$, $L_a > L_i + L_{cable}$.

For C_{cable} and L_{cable} , if the capacitance per foot or the inductance per foot is not known, then the following values shall be used: $C_{cable} = 60\text{pF/foot}$ and $L_{cable} = 0.2\mu\text{H/foot}$.

Contact current: $I_{max} = 50\text{mA}$

Contact voltage: $V_{max} = 35\text{V}$ (DC or AC)

Max. associated circuit capacitance $C_i = 0$

Max. associated circuit inductance $L_i = 0$

Not polarity requirement

12. FRONT SIDE AND USER ELEMENTS

Main unit shown below without battery compartment.

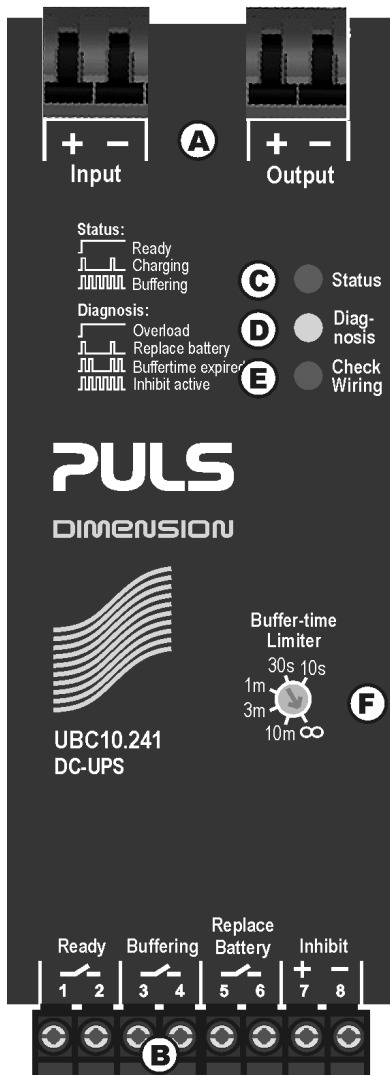

A Power Port

Quick-connect spring-clamp terminals, connection for input voltage and output voltage.

B Signal Port

Plug connector with screw terminals, inserted from the bottom. Connections for the Ready, Buffering, Replace Battery relay contacts and for the Inhibit input. See details in chapter 11.

C Green Status LED

Ready: Battery is charged > 85%, no wiring failures are recognized, input voltage is enough and inhibit signal is not active.

Charging: Battery is charging, and the battery capacity is below 85%.

Buffering: Unit is in buffer mode.

Flashing pattern of the green status LED:

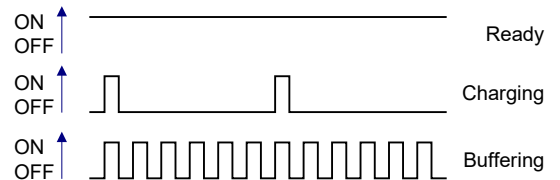

D Yellow Diagnosis LED

Overload: Output has switched off due to long overload in buffer mode or due to high temperatures.

Replace battery: Indicates a battery which failed the battery quality test (SoH test). Battery should be replaced as soon as possible.

Buffer-time expired: Output has switched off due to settings of Buffer-timer Limiter. This signal will be displayed for 15 minutes.

Inhibit active: Indicates that buffering is disabled due to an active inhibit signal.

Flashing pattern of the yellow diagnostic LED:

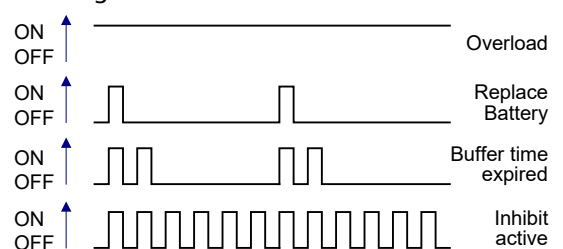

E Red Check Wiring LED

This LED indicates a failure in the installation (e.g. too low input voltage), wiring, battery or battery fuse.

F Buffer-time Limiter:

User accessible dial which limits the maximum buffer time in a buffer event to save battery energy. When the battery begins to recharge after a discharging event, the process is completed much faster since only the energy which was taken out of the battery needs to be "refilled". The following times can be selected: 10 seconds, 30 seconds, 1 minute, 3 minutes, 10 minutes or infinity (until battery is discharged) which allows buffering until the deep discharge protection stops buffering.

13. TERMINALS AND WIRING

	Power terminals	Signal terminals
Type	Bi-stable, quick-connect spring-clamp terminals. IP20 Finger-touch-proof. Suitable for field- and factory installation. Shipped in open position.	Plug connector with screw terminal. Finger-touch-proof construction with captive screws for 3.5mm slotted screwdriver. Suitable for field- and factory installation. Shipped in open position. To meet GL requirements, unused terminal compartments should be closed.
Solid wire	0.5-6mm ²	0.2-1.5mm ²
Stranded wire	0.5-4mm ²	0.2-1.5mm ²
AWG	20-10AWG	22-14AWG
Ferrules	Allowed, but not required	Allowed, but not required
Pull-out force	10AWG:80N, 12AWG:60N, 14AWG:50N, 16AWG:40N according to UL486E	Not applicable
Tightening torque	Not applicable	0.4Nm, 3.5lb.in
Wire stripping length	10mm / 0.4inch	6mm / 0.24inch

Fig. 13-1 Spring-clamp terminals, connecting a wire

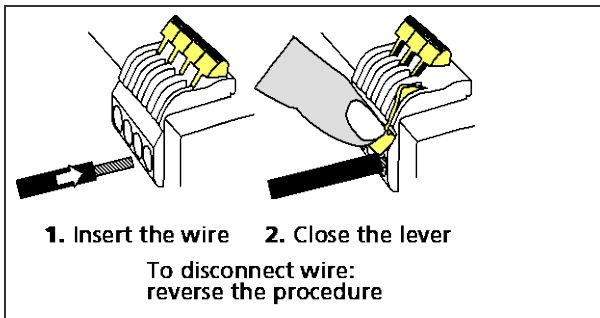

Instructions:

- a) Use appropriate copper cables, that are designed for an operating temperature of 60°C
- b) Follow national installation codes and regulations!
- c) Ensure that all strands of a stranded wire enter the terminal connection!
- d) Up to two stranded wires with the same cross section are permitted in one connection point

14. RELIABILITY

Lifetime expectancy	min.	137 400h	At 10A output current, 40°C
	min.	> 15 years	At 5A output current, 40°C
	min.	> 15 years	At 10A output current, 25°C
MTBF SN 29500, IEC 61709		886 000h	At 10A output current, 40°C
		1 482 000h	At 10A output current, 25°C
MTBF MIL HDBK 217F		397 900	At 10A output current, 40°C, ground benign GB40
		545 000	At 10A output current, 25°C, ground benign GB25

The **Lifetime expectancy** shown in the table indicates the operating hours (service life) and is determined by the lifetime expectancy of the built-in electrolytic capacitors. Lifetime expectancy is specified in operational hours. Lifetime expectancy is calculated according to the capacitor's manufacturer specification. The prediction model allows a calculation of up to 15 years from date of shipment.

MTBF stands for **Mean Time Between Failure**, which is calculated according to statistical device failures and indicates reliability of a device. It is the statistical representation of the likelihood of a unit to fail and does not necessarily represent the life of a product.

All values except battery.

15. EMC

The unit is suitable for applications in industrial environment as well as in residential, commercial and light industry environment without any restrictions. CE mark is in conformance with EMC guideline 89/336/EC and 93/68/EC and the low-voltage directive (LVD) 73/23/EC, 93/68/EC.

A detailed EMC Report is available on request.

EMC Immunity	EN 61000-6-1, EN 61000-6-2	Generic standards		
Electrostatic discharge	EN 61000-4-2	Contact discharge	8kV	Criterion A ^{*)}
		Air discharge	15kV	Criterion A ^{*)}
Electromagnetic RF field	EN 61000-4-3	80MHz-1GHz	10V/m	Criterion A
Fast transients (Burst)	EN 61000-4-4	Out- and input lines	2kV	Criterion A
		Signal lines ^{**)}	2kV	Criterion A
Surge voltage	EN 61000-4-5	Output + → -	500V	Criterion A
		Input + → -	500V	Criterion A
		+ / - → housing	500V	Criterion A
Conducted disturbance	EN 61000-4-6	0,15-80MHz	10V	Criterion A

^{*)} DIN rail earthed

^{**)} Tested with coupling clamp

EMC Emission	EN 61000-6-3, EN 61000-6-4	Generic standards		
Conducted emission	EN 55032 EN 55032	Input lines	Class B ^{*)}	
		Output lines	Class B ^{*)}	
Radiated emission	EN 55011, EN 55032		Class B	

This device complies with FCC Part 15 rules.

Operation is subjected to the following two conditions: (1) this device may not cause harmful interference, and (2) this device must accept any interference received, including interference that may cause undesired operation.

^{*)} Informative measurement with voltage probe

Switching frequencies	The DC-UPS has three converters with three different switching frequencies included.		
Switching frequency of boost converter	100kHz	Constant frequency	
Switching frequency of electronic output current limitation	78kHz	Constant frequency	
Switching frequency of battery charger	19.5kHz	Constant frequency	

16. ENVIRONMENT

Operational temperature	0°C to +40°C (32°F to 104°F)	Full output power
Storage temperature	-20°C to +50°C (-4°F to 122°F)	Storage and transportation
Humidity	5 to 95% r.H.	IEC 60068-2-30 Do not energize while condensation is present
Vibration sinusoidal	2-17.8Hz: ±1.6mm; 17.8-500Hz: 1g ^{*)}	IEC 60068-2-6
Shock	15g 6ms, 10g 11ms ^{*)}	IEC 60068-2-27
Altitude	0 to 6000m	Approvals apply only up to 2000m
Over-voltage category	III	EN 50178
	II	EN 50178 above 2000m altitude
Degree of pollution	2	EN 50178, not conductive

*) Use wall mounting accessory for higher values.

Fig. 16-1 **Normal Mode: Output current vs. ambient temperature**

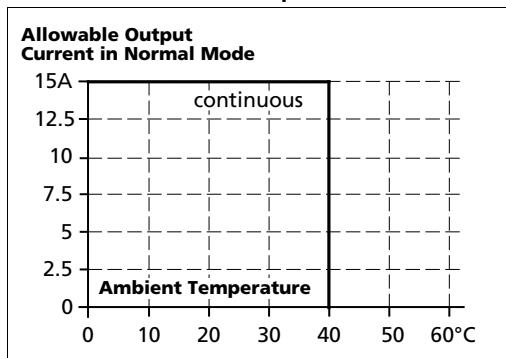
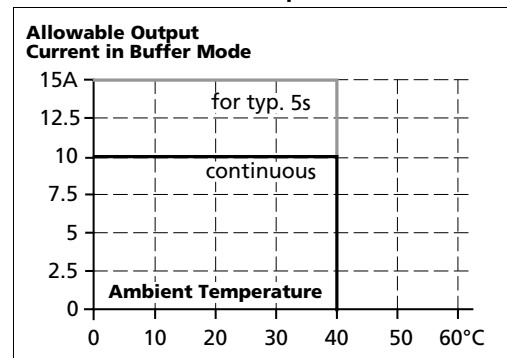

Fig. 16-2 **Buffer Mode: Output current vs. ambient temperature**



The ambient temperature is defined 2cm below the unit.









17. PROTECTION FEATURES

Output protection	Electronically protected against overload, no-load and short-circuits	
Output over-voltage protection in buffer mode	typ. 32Vdc max. 35Vdc	In case of an internal defect, a redundant circuitry limits the maximum output voltage. The output automatically shuts-down and makes restart attempts.
Degree of protection	IP20	EN/IEC 60529
Penetration protection	> 3.5mm	E.g. screws, small parts
Reverse battery polarity protection	yes	Max. -35Vdc;
Wrong battery voltage protection	yes	Max. +35Vdc (e.g. 24V battery instead of 12V battery)
Battery deep discharge protection	yes	The limit is battery current dependent
Over temperature protection	yes	Output shutdown with automatic restart
Input over-voltage protection	yes	Max. 35Vdc, no harm or defect of the unit
Internal input fuse	25A, blade type	No user accessible part, no service part

18. SAFETY

Output voltage	SELV PELV Max. allowed voltage between any input, output or signal pin and ground: 60Vdc or 42.4Vac	IEC/EN 60950-1 EN 60204-1, EN 50178, IEC 60364-4-41
Class of protection	II	PE (Protective Earth) connection is not required
Isolation resistance	> 5M Ω	Power port to housing, 500Vdc
Dielectric strength	500Vac	Power port to signal port
	500Vac	Power port / signal port to housing
Touch current (leakage current)	The leakage current which is produced by the DC-UPS itself depends on the input voltage ripple and need to be investigated in the final application. For a smooth DC input voltage, the produced leakage current is less than 100 μ A.	

19. APPROVED, FULFILLED OR TESTED STANDARDS

UL 508		UL Certificate Listed equipment for category NMTR - Industrial Control Equipment Applicable for US and Canada E-File: E198865
IEC 60950-1	CB Report	CB Scheme Certificate General safety requirements for Information Technology Equipment (ITE)
UL 60950-1		UL Certificate Recognized component for category QQGQ - Information Technology Equipment (ITE) Applicable for US and Canada E-File: E137006
ATEX		Agency Certificate (Bureau Veritas) EN 60079-0 Explosive atmospheres - General requirements EN 60079-7, EN 60079-15 Equipment protection by type of protection "e" and "n" Certificate: EPS 15 ATEX 1 025 X Temperature Code: T3 Type of Protection: ec nC
IECEX		IECEX Certificate IEC 60079-0 Explosive atmospheres - General requirements IEC 60079-7, IEC 60079-15 Equipment protection by type of protection "e" and "n" Certificate: IECEX EPS 15.0049X Temperature Code: T3 Type of Protection: ec nC
Class I Div 2		UL Certificate Recognized component for category QQPX - Power Supplies for Use in Hazardous Locations Applicable for US and Canada E-File: E246847 Temperature Code: T3 Groups: A, B, C and D
Marine (DNV)		DNV Certificate DNV Type approved product Certificate: TAA00001ST Temperature: Class A Humidity: Class B Vibration: Class C EMC: Class A Enclosure: Class A
Marine (ABS)		ABS Design Assessment Certificate ABS (American Bureau of Shipment) assessed product Certificate: 17-HG1599236-PD
UL 1989		Vendor Certificate Standard for Standby Batteries UL94: HB

IEC 60068-2-60

Corrosion
IEC 60068-2-60
Method 4 ✓

Manufacturer's Declaration (Online Document)
Environmental Tests, Flowing Mixed Gas Corrosion Test
Test Ke - Method 4
H2S: 10ppb
NO2: 200ppb
Cl2: 10ppb
SO2: 200ppb
Test Duration: 3 weeks, which simulates a service life of 10 years.

ISA-71.04 G3

Corrosion
G3-ISA-71.04 ✓

Manufacturer's Declaration (Online Document)
Airborne Contaminants Corrosion Test
Severity Level: G3 Harsh
H2S: 100ppb
NOx: 1250ppb
Cl2: 20ppb
SO2: 300ppb
Test Duration: 3 weeks, which simulates a service life of 10 years

VDMA 24364

LABS
VDMA 24364-C1-L/W

Paint Wetting Impairment Substances Test (or LABS-Test)
Tested for Zone 2 and test class C1 according to VDMA 24364-C1-L/W for solvents and water-based paints

20. REGULATORY PRODUCT COMPLIANCE

EU Declaration of
Conformity



The CE mark indicates conformance with the
- EMC directive
- Low-voltage directive
- RoHS directive

REACH Directive



Manufacturer's Statement
EU-Directive regarding the Registration, Evaluation,
Authorization and Restriction of Chemicals

WEEE Directive



Manufacturer's Statement
EU-Regulation on Waste Electrical and Electronic Equipment
Registered in Germany as business to business (B2B) products.

KC Korean Certificate



KC Registration
Korean registration of Broadcasting and Communication
Equipment
Registered under Clause 3, Article 58-2 of Radio Waves Act.

EAC TR Registration



EAC Certificate
EAC EurAsian Conformity - Registration Russia, Kazakhstan
and Belarus
8504408200, 8504409000

21. PHYSICAL DIMENSIONS AND WEIGHT

Width	123mm / 4.84"	
Height	124mm / 4.88"	Plus, height of signal connector plugs and Spare fuse
Depth	119mm / 4.69"	Plus, depth of DIN rail
Weight	2850g / 6.28lb	
DIN-Rail	Use 35mm heavy duty DIN rails according to EN 60715 or EN 50022. The DIN rail depth must be added to the depth (119mm) to calculate the total required installation depth.	

Electronic files with mechanical data can be downloaded at www.pulspower.com

Fig. 21-1 **Side view**

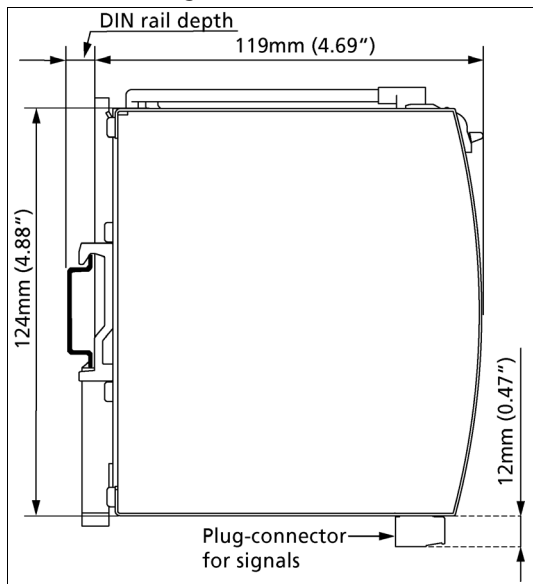
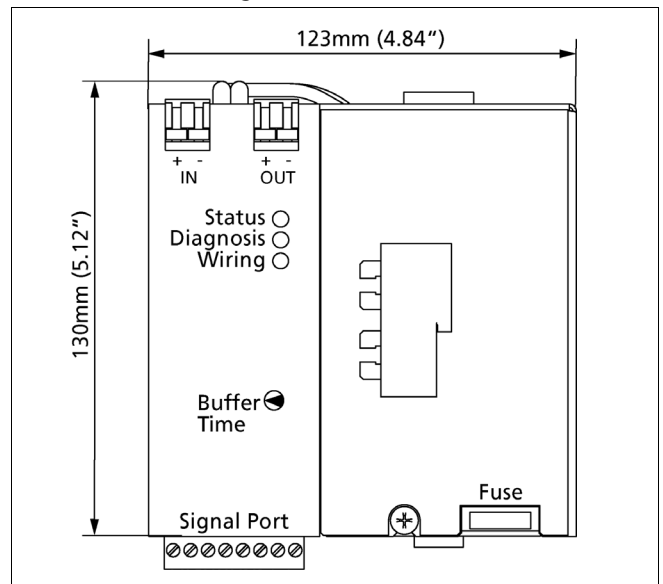

Fig. 21-2 **Front view**



22. INSTALLATION NOTES

Mounting:

The power terminals shall be located on top of the unit. An appropriate electrical and fire end-product enclosure should be considered in the end use application.

Do not install unit in airtight housings or cabinets. The site in which the unit is located must have sufficient ventilation acc. to EN50272-2.

Cooling: Convection cooled; no forced air cooling required. Do not obstruct air flow!

Installation clearances: 40mm on top, 20mm on the bottom, 5mm on the left and right side are recommended when loaded permanently with full power. In case the adjacent device is a heat source, 15mm clearance are recommended.

Risk of electrical shock, fire, personal injury or death!

Turn power off and disconnect battery fuse before working on the DC-UPS. Protect against inadvertent re-powering. Make sure the wiring is correct by following all local and national codes. Do not open, modify or repair the unit, except replacement of the battery. Use caution to prevent any foreign objects from entering the housing. Do not use in wet locations or in areas where moisture or condensation can be expected.

Service parts:

The DC-UPS contains an integrated battery which must be changed on a periodic basis, see chapter 23 and. 25.1.

The tripping of an internal fuse is caused by an internal fault. If damage or malfunctioning should occur during operation, immediately turn power off and send unit to the factory for inspection! For Troubleshooting see 25.4.

Wiring and installation instructions:

- (1) It is recommended to install the DC-UPS in a place where the integrated battery will not be heated up by adjacent equipment. The unit is equipped with a fuse holder and a 30A battery fuse type ATO® 257 030 (Little fuse). The battery fuse protects the wires between the battery and the DC-UPS. It also allows the disconnection of the battery from the DC-UPS which is recommended when working on the battery or DC-UPS. Disconnect battery fuse before connecting the battery.
- (2) Connect the power supply to the input terminals of the DC-UPS.
- (3) Connect the buffered load to the output terminals of the DC-UPS. The output is decoupled from the input allowing load circuits to be easily split into buffered and non buffered sections. Noncritical loads can be connected directly to the power supply and will not be buffered. The energy of the battery can then be used in the circuits which require buffering.
- (4) Plug-in the fuse when the wiring is finished.

Fig. 22-1 Typical wiring diagram

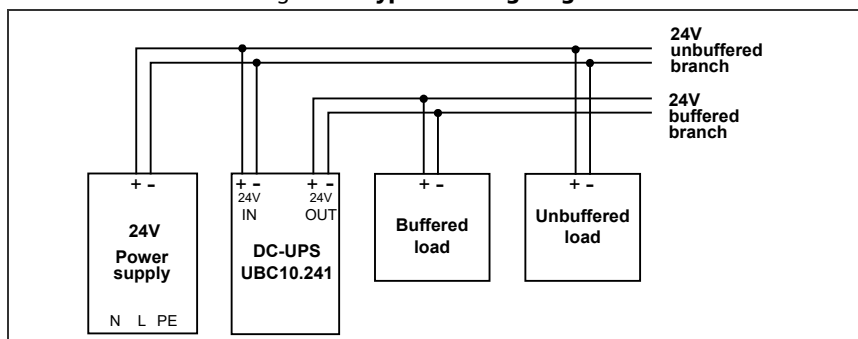

23. REPLACEMENT OF THE BATTERY

The integrated battery should be replaced on a periodic basis, see chapter 25.1 for additional information.

The replacement should be done by qualified personnel trained on battery handling.

Caution! The terminals on the battery are always alive, therefore do not place items or tools on the battery!

How to replace the battery:

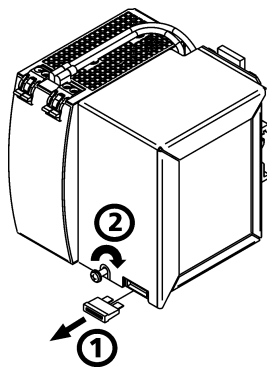

Step 1:
Remove the fuse before working on the unit.

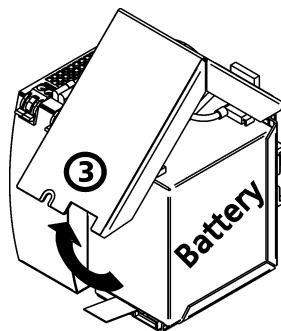

Step 2:
Loosen the captive cover screw.

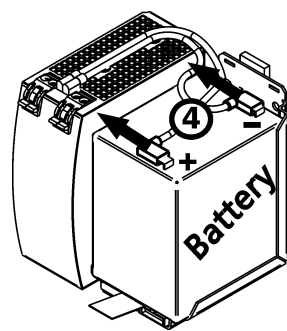

Step 3:
Remove the battery-cover.

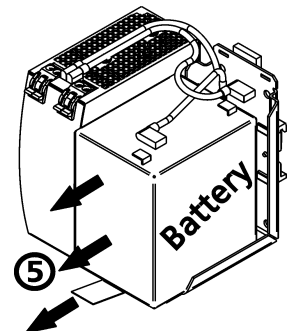

Step 4:
Disconnect the cables from the battery terminals.

Step 5:
Remove the battery by pulling on the strap.

Step 6: Install the new battery.

Step 7: Connect the red cable (+) to the red positive (+) terminal of the battery.

Step 8: Connect the black cable (-) to the black negative (-) terminal of the battery.

Step 9: Close the cover.

Step 10: Tighten the screw.

Step 11: Plug-in the fuse.

Disposal of batteries

Batteries marked with the recycling symbol should be recycled through a competent agency.



Replacement battery

See chapter 24 for information on the UZB12.051 or you can use a battery which meets the following requirements:

Battery type	nom.	12V, 4 to 6Ah	VRLA lead-acid maintenance free battery
Design life	min.	3 to 5 years	According to EUROBAT guideline
Dimensions	nom.	70x106x90mm	WxHxD ^{*)}
Pole connection		6.35mm/ 0.25Inch	Blade type; Fast-on
Approvals		UL, VdS	For applications which require UL or VdS
Allowed discharge current	min.	29A	Continuous

*) Max. case height of 102mm

24. ACCESSORIES

24.1. BATTERY

The integrated battery should be replaced on a periodic basis, see chapter 25.1.
As replacement the UZB12.051 can be used.

UZB12.051		
Battery type	High current version 12V, 5Ah	VRLA lead-acid maintenance free battery
Design life	3 to 5 years	According to EUROBAT guideline
Dimensions	70x106x90mm	Width x total height x depth
Pole connection	6.35mm/ 0.25Inch	Blade type; Fast-on
Weight	2kg/ 4.41lb	
Order number	UZB12.051	Battery for UBC10.241

Fig. 24-1 **UZB12.051**



Wall mounting bracket

Type ZM1.UBC10 is under preparation, please consult PULS.

25. APPLICATION NOTES

25.1. BATTERY REPLACEMENT INTERVALS

Batteries have a limited lifetime. They degrade slowly beginning from the production and need to be replaced periodically. The design life figures can be found in the individual datasheets of the batteries and usually is specified according to the Eurobat guideline or according to the manufacturer's specifications.

The design life is the estimated life based on laboratory condition and is quoted at 20°C using the manufacturer's recommended float voltage condition. According to the Eurobat guideline, design lives have been structured into the following different groups:

- 3 - 5 years: This group of batteries is very popular in standby applications and in small emergency equipment. This represents a 4 years design life with a production tolerance of ± 1 year.
- 6 - 9 years: This group of batteries is usually used when an improved life is required. This represents a 7.5 years design life with a production tolerance of ± 1.5 years.
- 10 - 12 years: This group of batteries is used when in applications where longest life and highest safety level are required. This represents a 11 years design life with a production tolerance of ± 1 year.

A battery failure within the specified design life of the battery usually results in a complete loss of the battery function (broken cell, defect connection, ...) and will be detected and reported by the periodical battery tests which are included in the UBC10.241 DC-UPS control unit.

If the operational parameters differ from those which are specified for the design life, an earlier change of the battery might be necessary. The "real life" is called service life and is defined as the point at which the cell's actual capacity has reached 80% of its nominal capacity. At the end of the service life the capacity degrades much faster, so that a further use of the battery is not recommended.

Temperature effect:

The temperature has the most impact in the service life. The hotter the temperature, the earlier the wear-out phase of the battery begins. The wear-out results in a degradation of battery capacity. See Fig. 25-1 for details.

Effect of discharging cycles

The number as well as the depth of discharging cycles is limited. A replacement of the battery might be necessary earlier than the calculated service life if the battery exceeds the numbers and values of Fig. 25-2.

Other effects which shorten the service life

- Overcharging and deep discharging shortens the service life and should be avoided. Thanks to the single battery concept of the UBC10.241, the end-of-charge voltage is precisely set automatically avoiding unnecessary aging effects.
- Charge retention is important to get the longest battery life. Stored batteries which are not fully charged age faster than charged batteries. Batteries which are not in use should be recharged at least once a year.
- Excessive float charge ripple across the battery has an effect of reducing life and performance. The UBC10.241 does not produce such a ripple voltage. This effect can be ignored when the battery is charged with the UBC10.241.

Guidelines for a long battery service life:

- Place the DC-UPS in a cool location: E.g. near the bottom of the control cabinet.
- Do not place the DC-UPS near heat generating devices.
- Do not store discharged batteries.
- Do not discharge the battery more than necessary. Set buffer time limiter to the required buffer time.
The depth of discharge reduces the service life of the battery and limits the number of cycles. See Fig. 25-2.

Example for calculating the service life and the required replacement cycle:

Parameters for the example:

- A 5Ah battery with a design life of 3-5 years is used (e.g. Yuasa battery which is used for type UZB12.051)
- The average ambient temperature is 30°C
- One buffer event consumes approx. 25% of the achievable buffer time.
- One buffer event per day

Calculation:

Ambient temperature influence:

According to Fig. 25-1 curve A, a 2 years service life can be expected for an ambient temperature of 30°C.

Number of discharging cycles: 2 years * 365 cycles = 730cycles in 2 years.

According to Fig. 25-2, curve C has to be used (only 25% of battery capacity is required). 730 cycles have only a negligible influence in a battery degradation and can be ignored.

Result:

The battery shall be replaced after 2 years.

Please note that the battery degrading begins from the production date (check date code on the battery) which may shorten the replacement intervals.

Fig. 25-1 Service life versus ambient temperatures, typ *)

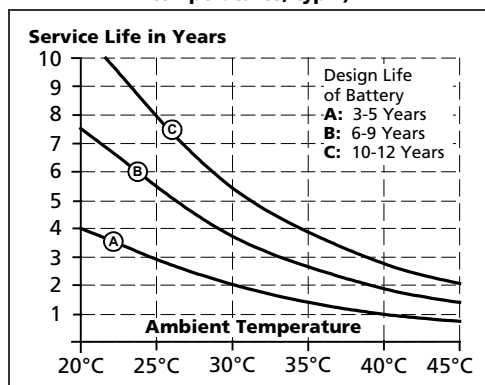
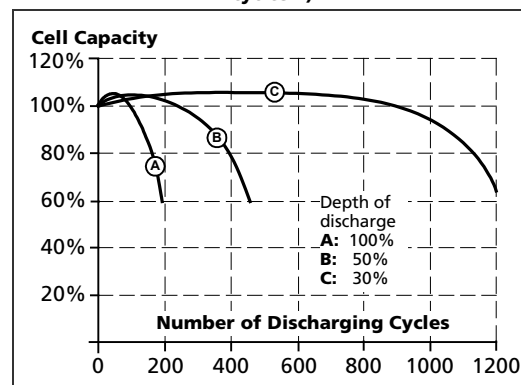

Fig. 25-2 Cell capacity degradation vs. discharging cycles *)



*) datasheet figures from battery manufacturer

25.2. PARALLEL AND SERIAL USE

Do not use the DC-UPS in parallel to increase the output power. However, two units of the DC-UPS can be paralleled for 1+1 redundancy to gain a higher system reliability.

Do not use batteries in parallel, since the battery quality test might create an error message.

Do not connect two or more units in series for higher output voltages.

Do not connect two or more units in a row to get longer hold-up times.

25.3. USING THE INHIBIT INPUT

The inhibit input disables buffering. In normal mode, a static signal is required. In buffer mode, a pulse with a minimum length of 250ms is required to stop buffering. The inhibit is stored and can be reset by cycling the input voltage.

For service purposes, the inhibit input can also be used to connect a service switch. Therefore, the inhibit signal can be supplied from the output of the DC-UPS.

Fig. 25-3 **Wiring example for inhibit input**

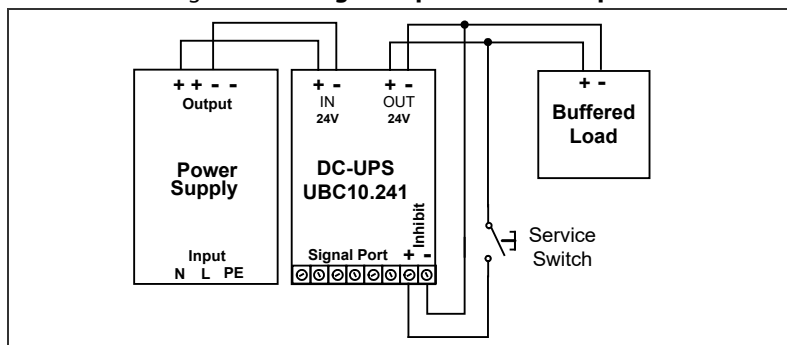

25.4. TROUBLESHOOTING

The LEDs on the front of the unit and relay contacts indicate the status of the DC-UPS. Please see also chapter 12.

The following guidelines provide instructions for fixing the most common failures and problems. Always start with the most likely and easiest-to-check condition. Some of the suggestions may require special safety precautions. See notes in chapter 22 first.

- “Check wiring” LED is on**
 - Check correct wiring between the battery and the DC-UPS
 - Check battery fuse. Is the battery fuse inserted or blown?
 - Check battery voltage (must be typically between 7.4V and 15.1V)
 - Check input voltage (must be typically between 22.8V and 30V)
 - Check battery polarity
- DC-UPS did not buffer**
 - Inhibit input was set
 - Battery did not have enough time to be charged and is still below the deep discharge protection limit.
- DC-UPS stopped buffering**
 - Buffer time limiter stopped buffering → set buffer time limiter to a higher value
 - Deep discharge protection stopped buffering → allow enough time for charging the battery
 - Output was overloaded or short circuit → reduce load
- Output has shut down**
 - Cycle the input power to reset the DC-UPS
 - Let DC-UPS cool down, over temperature protection might have triggered.
- DC-UPS constantly switches between normal mode and buffer mode**
 - The supplying source on the input is too small and can not deliver enough current → Use a larger power supply or reduce the output load
 - The input voltage is same as transfer threshold. → Increase input voltage